



MEGA YOUNG
兆 扬

兆扬筛分技术有限公司

MEGA YOUNG SCREENING TECHNOLOGY CO., LTD



M MODEL

GYRATORY SCREENER



Website: www.megayoungscreen.com

Email: info@megayoungscreener.com

gyratoryscreen@hotmail.com



MEGA YOUNG
兆扬

CONTENTS

Working principle

Material flow

Screen deck

Self-cleaning ball

Seal structure

Installation

Application

Parameter

Material data

Our Service

Factory



Henan Mega Young Screening Technology Co.,Ltd as one professional company in researching and developing and selling M&Y gyrotory screener, we have strong production capacity and plenty customer who applied our gyrotory screener, so we believe we Mega Young Screening could offer you the proper screening solution and gyrotory screener.

MEGA YOUNG SCREENING TECHNOLOGY CO.,LTD
河南兆扬筛分技术有限公司

Address: No.4 Workshop, 863Industrial Park, Intersection
of Xindong Road and Dongzhuo Road Southwest,
Xinxiang City, China

Tel:0086-373 2698111/222

Whatspp: 0086-13781913175

Email: gyrotoryscreen@hotmail.com

info@megayoungscreener.com

Website: www.megayoungscreen.com



Working Principle

M series Gyrotory Screener is one kind of precision screener, which could screen particle material, powder material and irregularly shaped material. Compare with some other heavy duty screener, its screening precision is higher, compare with some other precision screener, its capacity is larger.

Right picture show how the gyrotory screener work with two layer mesh decks, the screener could separate the material into three size specification scope material. Our M series gyrotory screener could be with 1-4 layers of mesh deck.

Remark: Because this screener deck with low slop angle, so the projection size of screen mesh aperture to ground is similar with the fact screen mesh aperturesize, so the screened material could meet customer's request much more.

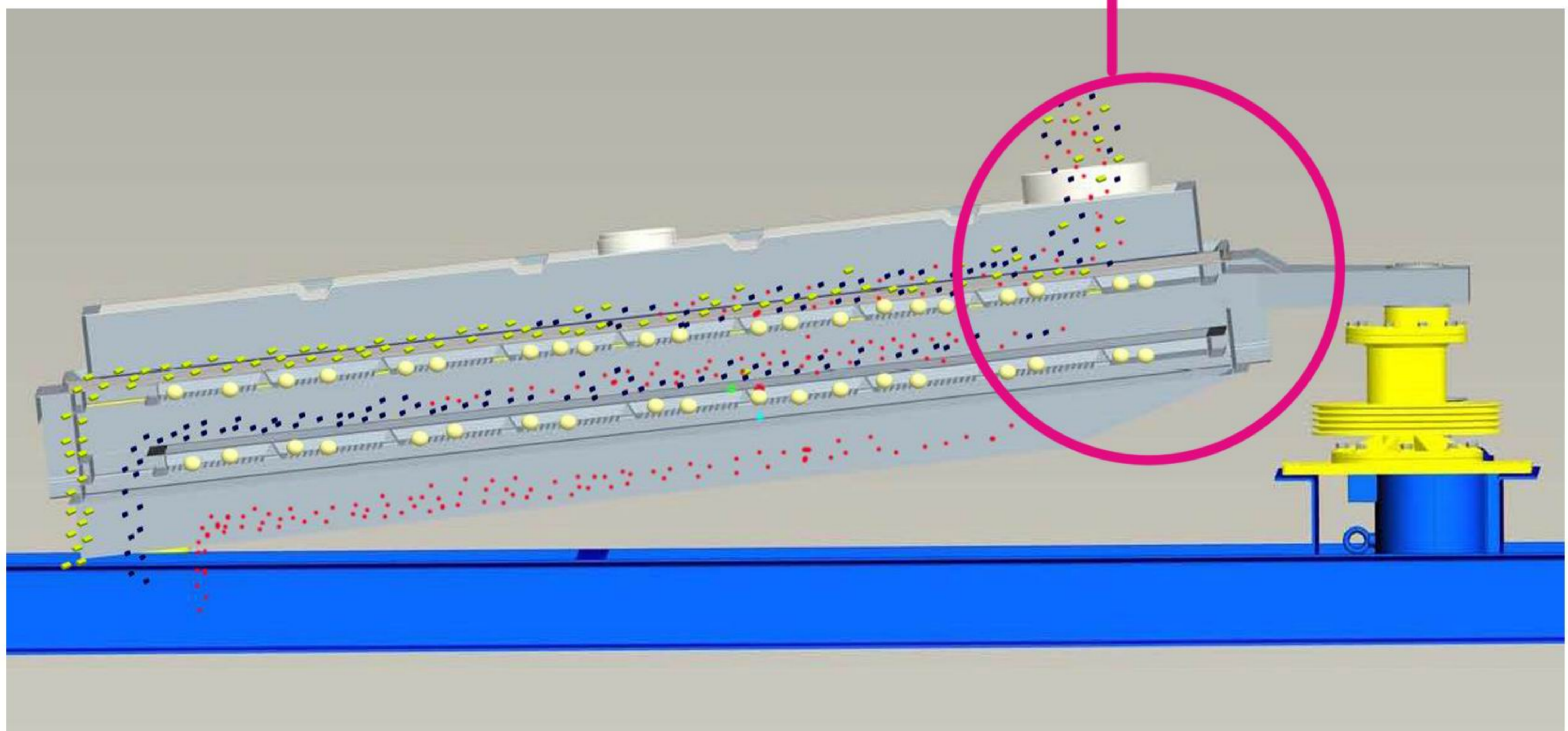
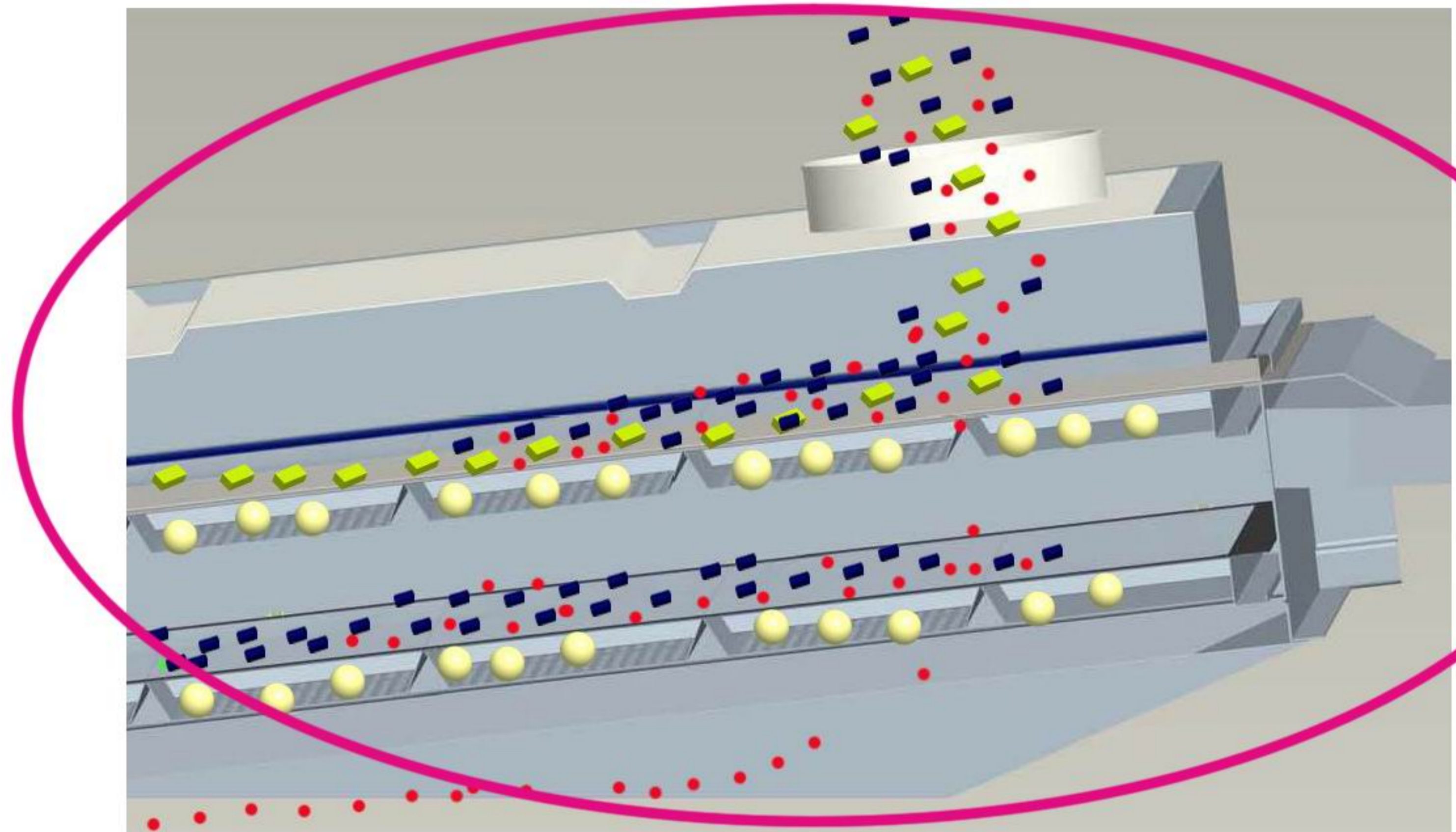

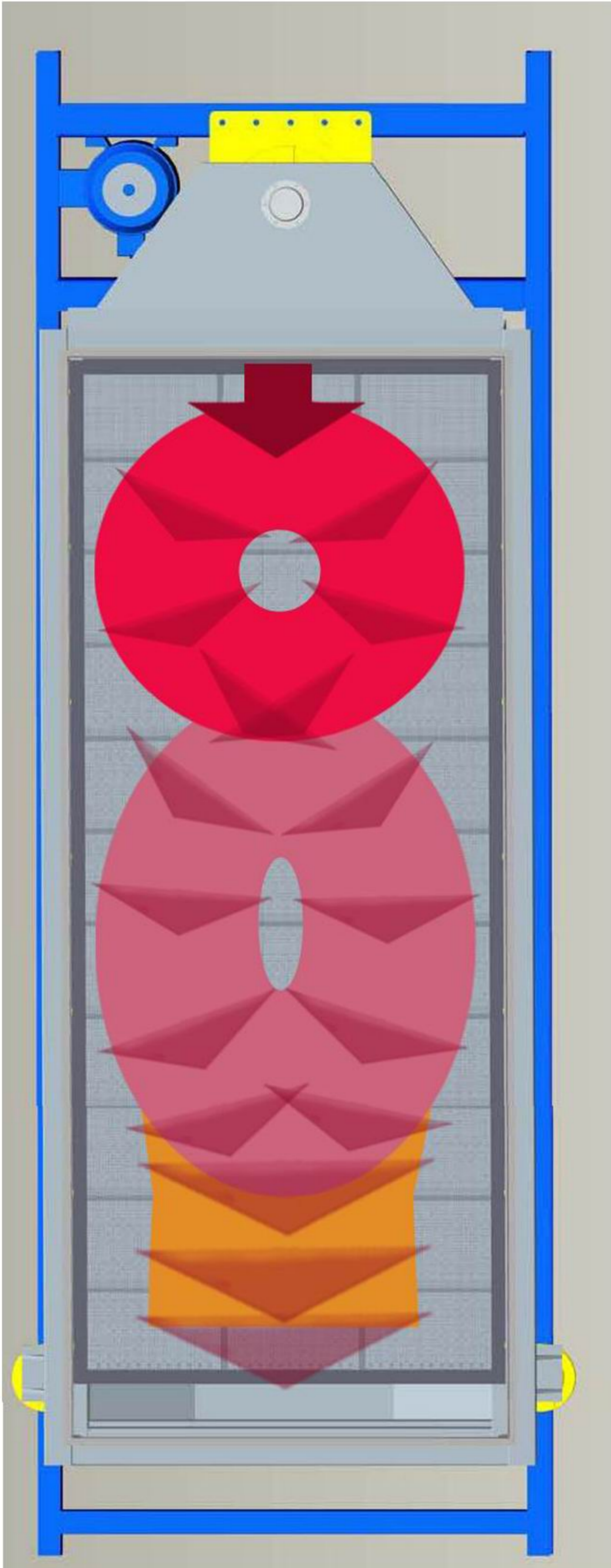

During screening, the material movement track is varied, we could take the complete screening process from feeding to outputting as three stages:

Stage 1: Under the screen box gyratory circular movement, the material will be distributed evenly on the whole width of the screen deck after material feed into the inlet of the screener, some little size material start pass through the screen deck. In this stage, it is mainly for distribute the material.

Stage 2: Along with the material flow toward the outlet, the material movement track will become elliptical. In this stage, the material bed has been cover the screen deck evenly, and the thickness is suitable for screening, so the equipment could screen the material adequately in this stage.

Stage 3: In this stage, the material flow has been near the screen outlet after stage 2, the material screening work almost be finished after previous 2 stages, the material movement track will become linear from elliptical gradually, the material movement distance will be shorter, so the material over screen aperture size will flow toward the outlet soon.



Stage 3
Flow out



Stage 2
Material distribute evenly



Stage 1
Material distribute at inlet



The screener deck is one combination structure consist of screen mesh, self-cleaning ball and support deck frame. The wooden screener deck is simple, we could fix the mesh on the wooden support deck frame via nail directly, if it is metal screener deck, we will fix the mesh on the metal support deck frame via rivet or fast spring clamp, the customer could select the wooden frame or metal frame base on their industry application.



Internal picture of deck

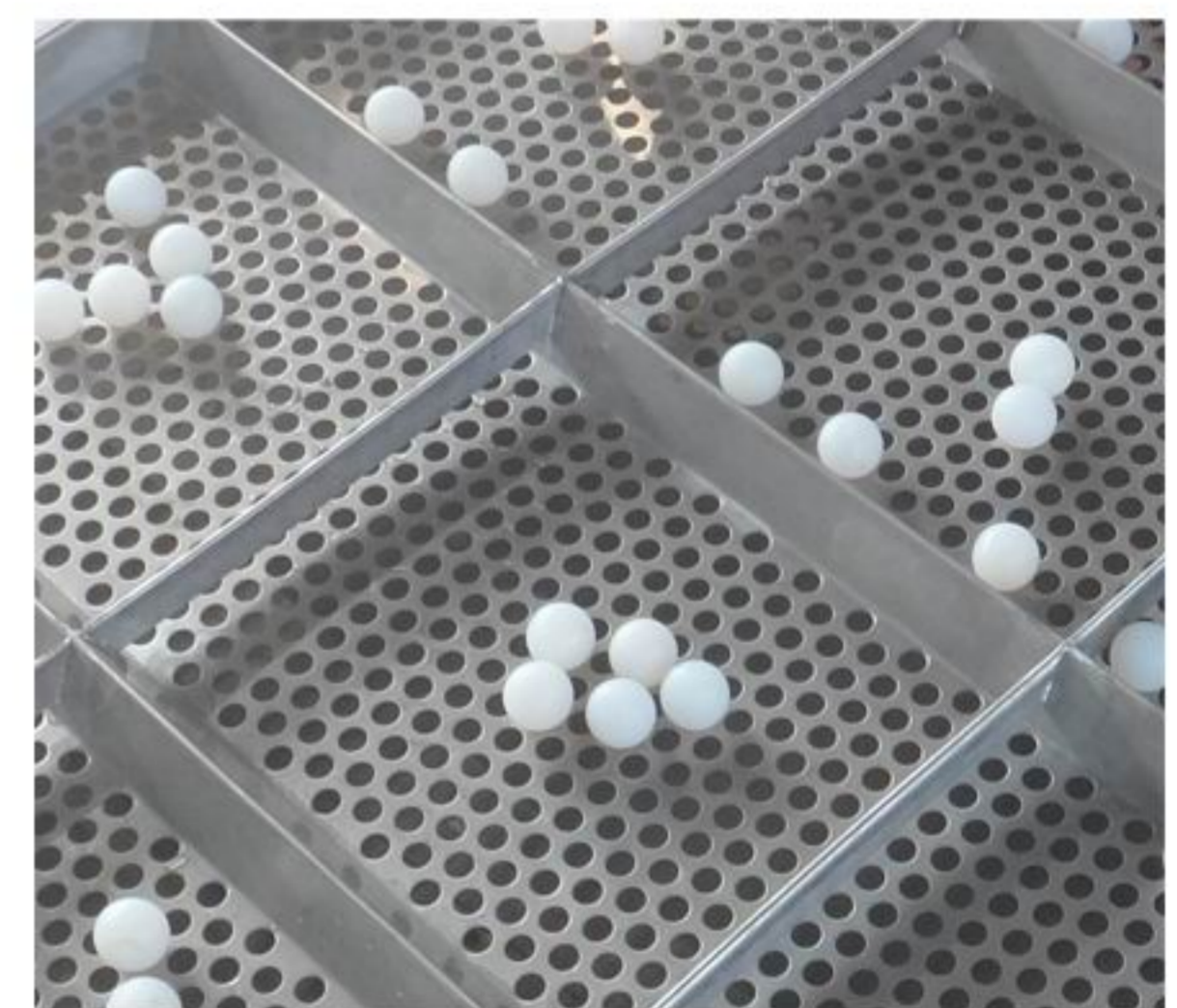

Self-cleaning ball



Screener Mesh



Support deck frame

The support screen deck is divided into several little cells, the four side of the cell could support the working mesh and share the pressure force, we put several self-cleaning ball in every little cells, The working mesh be with bordure structure that could be fixed via spring clamp.



MEGA YOUNG
兆 扬

Self-cleaning ball

Self-cleaning ball locate between screen mesh and support deck frame ,and the support screen deck is divided into several little cells evenly, the ball will hit the side frame of the support deck frame then rebound to screen mesh when screener working, this could avoid the material blocked in the screen aperture, so it could handle the powder material easily.



Seal Structure

There are well internal seal structure for the screener, it could avoid material flowing away from two side of the screen deck, it could guarantee the screening precision, the screener could screening 300 mesh material at least.



Fast change mesh

The screener mesh could be fixed on the support deck frame via fast spring clamp, we could change the screening mesh with the specific device easily, and we do not destroy old screen mesh during the operation.

Seal Principle



MEGA YOUNG
兆扬



Fast adjustable clamp

Fast adjustable clamp consist of adjustable screw and spring, we could open and fasten the clamp easily refer to lever principle, the pressure force of the clamp also could fasten the screener top cover.

Internal structure

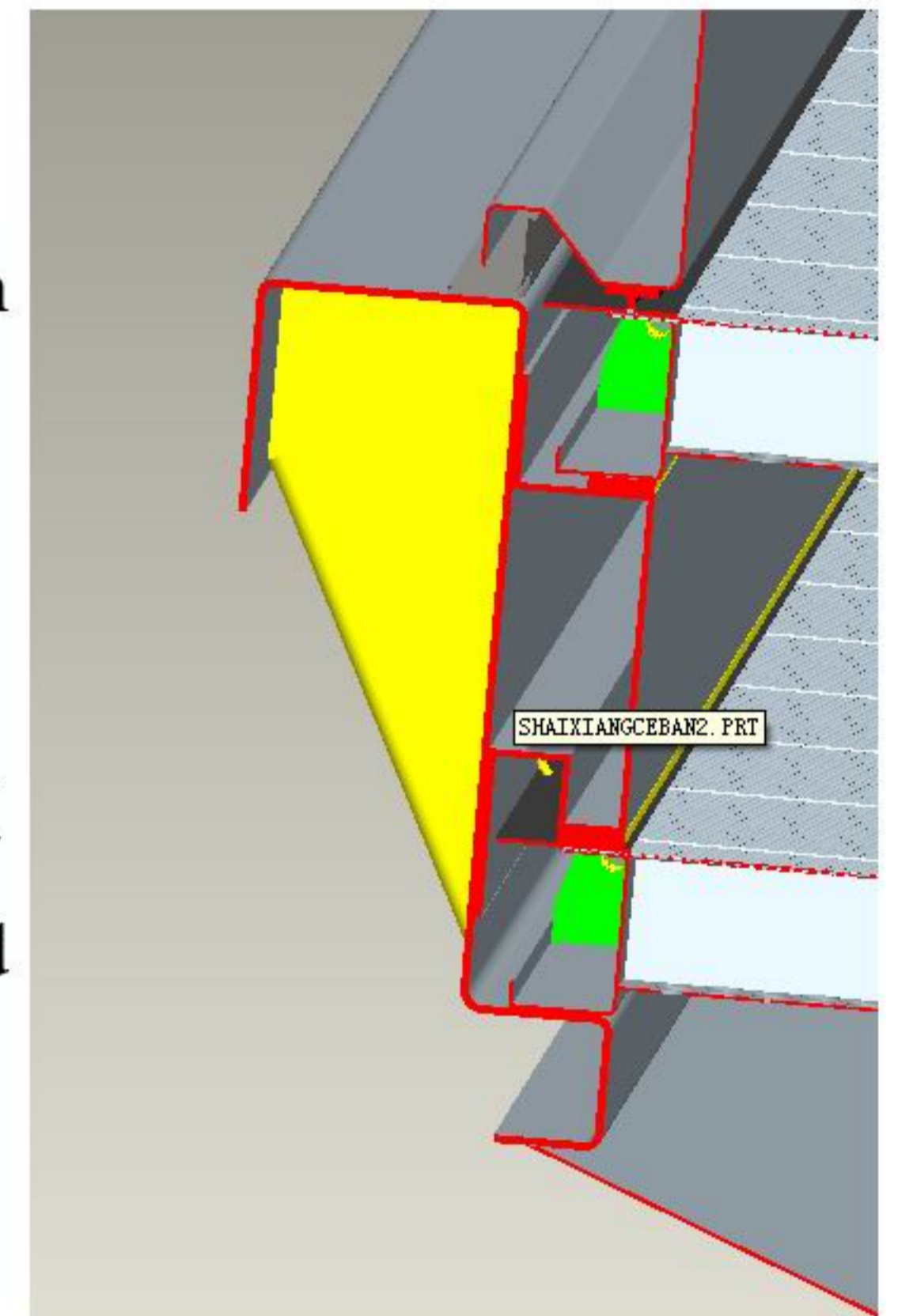

The screen deck is movable in M series Gyrotory screener, we should move out the screen deck from the screener box if we change the screen mesh, or we could put into the spare screener deck directly after moving out previous deck.

There is no any bolt or other fasten part between each two decks, it is mainly fastened via the gravity of the top deck and the pressure force of the fast spring clamp on top cover, and there are seal structure under screen deck and top cover, the gravity and pressure force could press the seal structure well that avoid the material flow away from the side of the deck.



Screeners structure



MEGA YOUNG
兆 扬

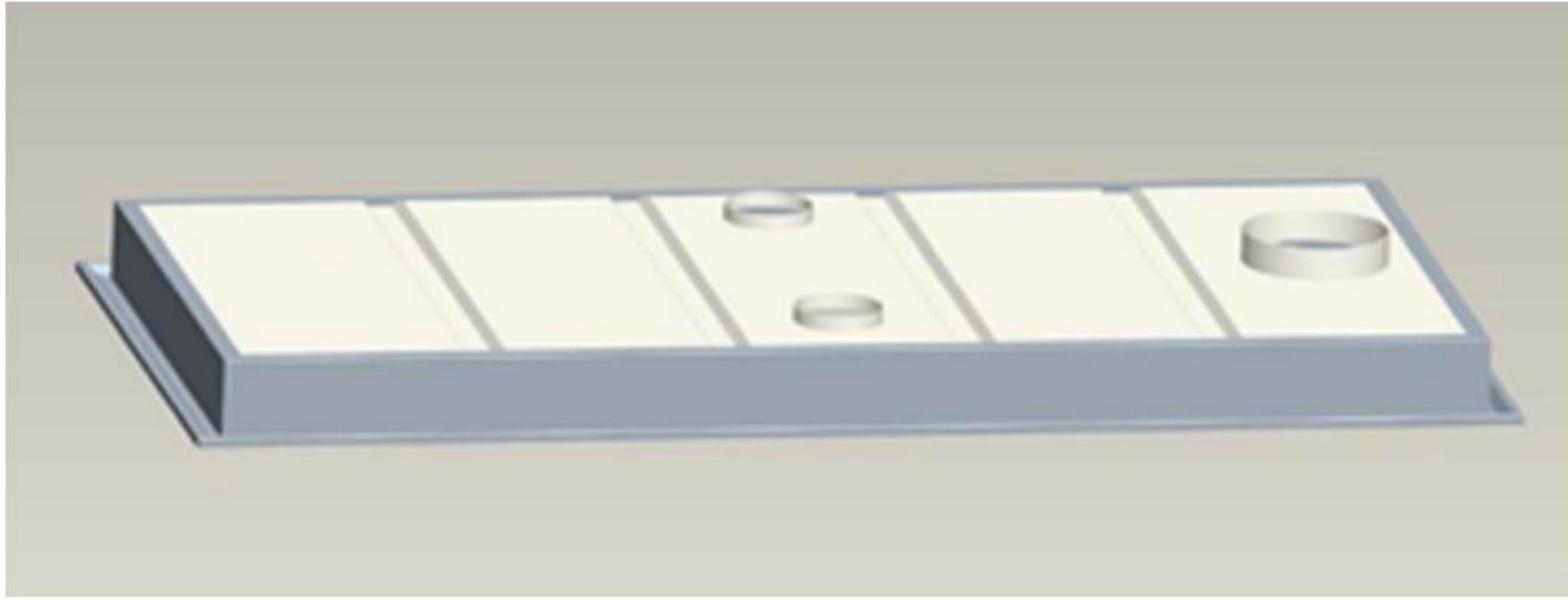

It is the sketch of pedestal type screener structure of M series as left pictures, the top is top cover, the screener deck could be 1-4 layers, one deck overlies on another deck, it is fastened via top cover and gravity. The screener base frame is under the screener box, the driving arrangement locates on the feeding end. The slide base support locates on the material discharging end. If the screener is suspension model, the material discharging end will be suspended via adjustable cable, and all the base frame is suspended via cable too and does not touch the ground.

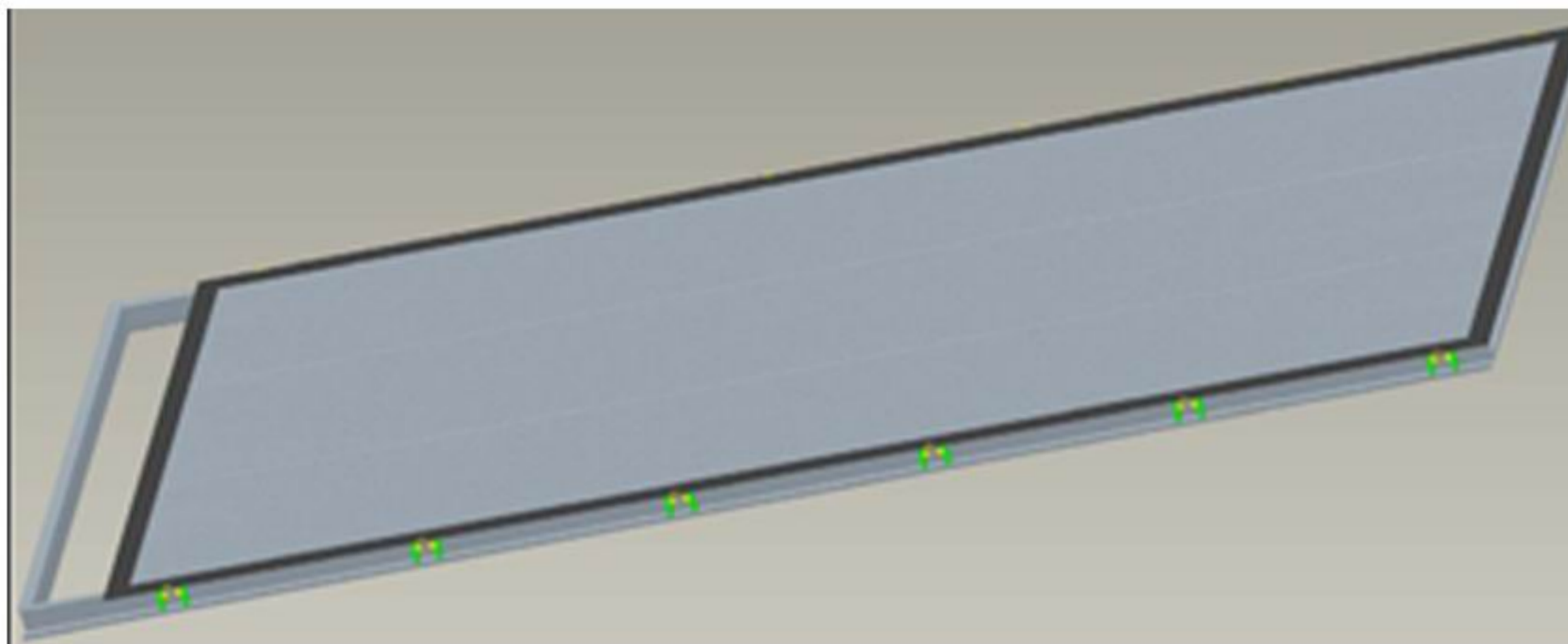

Left drawing is the metal suspension deck frame fit with fast spring clamp structure, it is mainly applied in chemical industry, food industry, it could meet the request on the health or anti-corrosion. If it is for screening some light material such as animal food, or the capacity of the screener is not large, we could select the wooden support deck frame, the structure is simple and could save some cost.

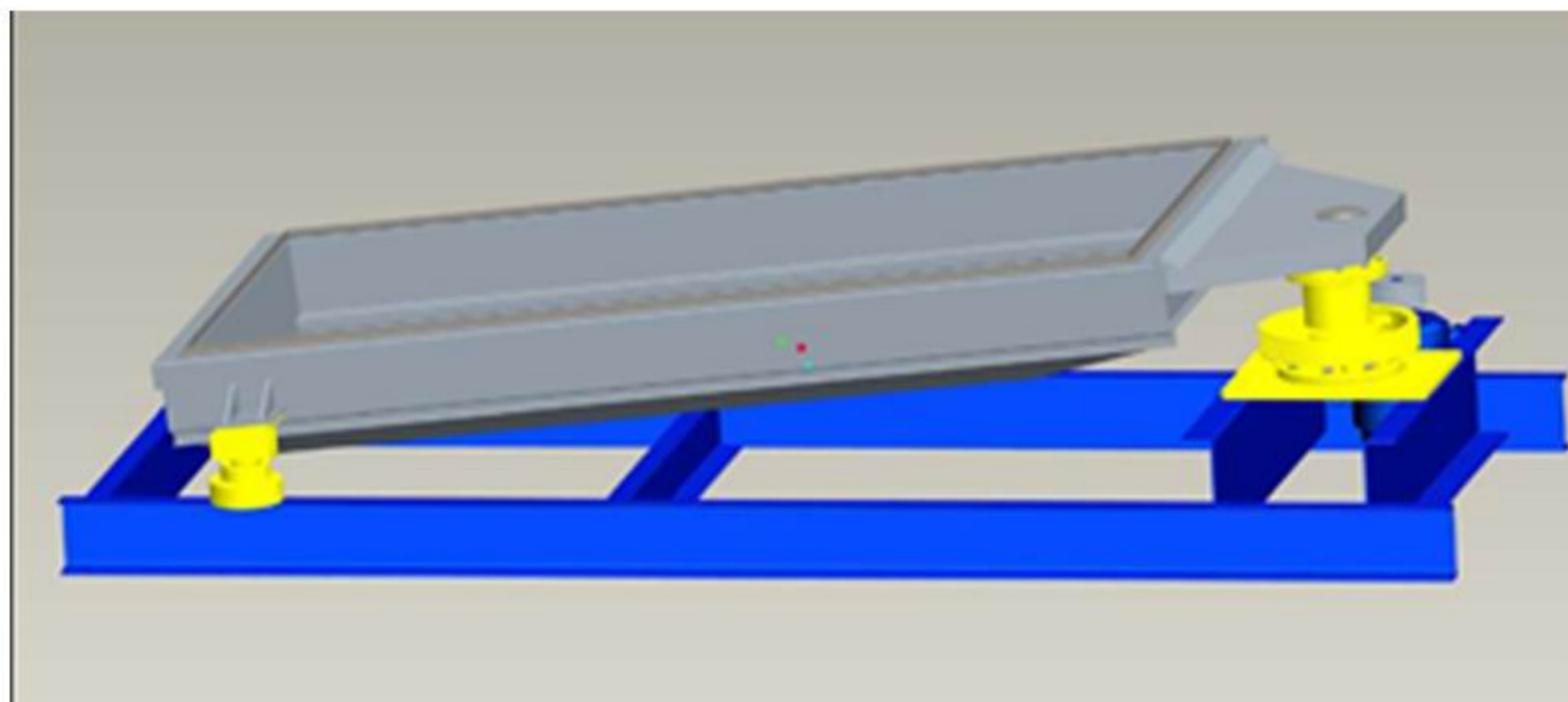

Mega Young Screening also could do some specific design if you have any special request.

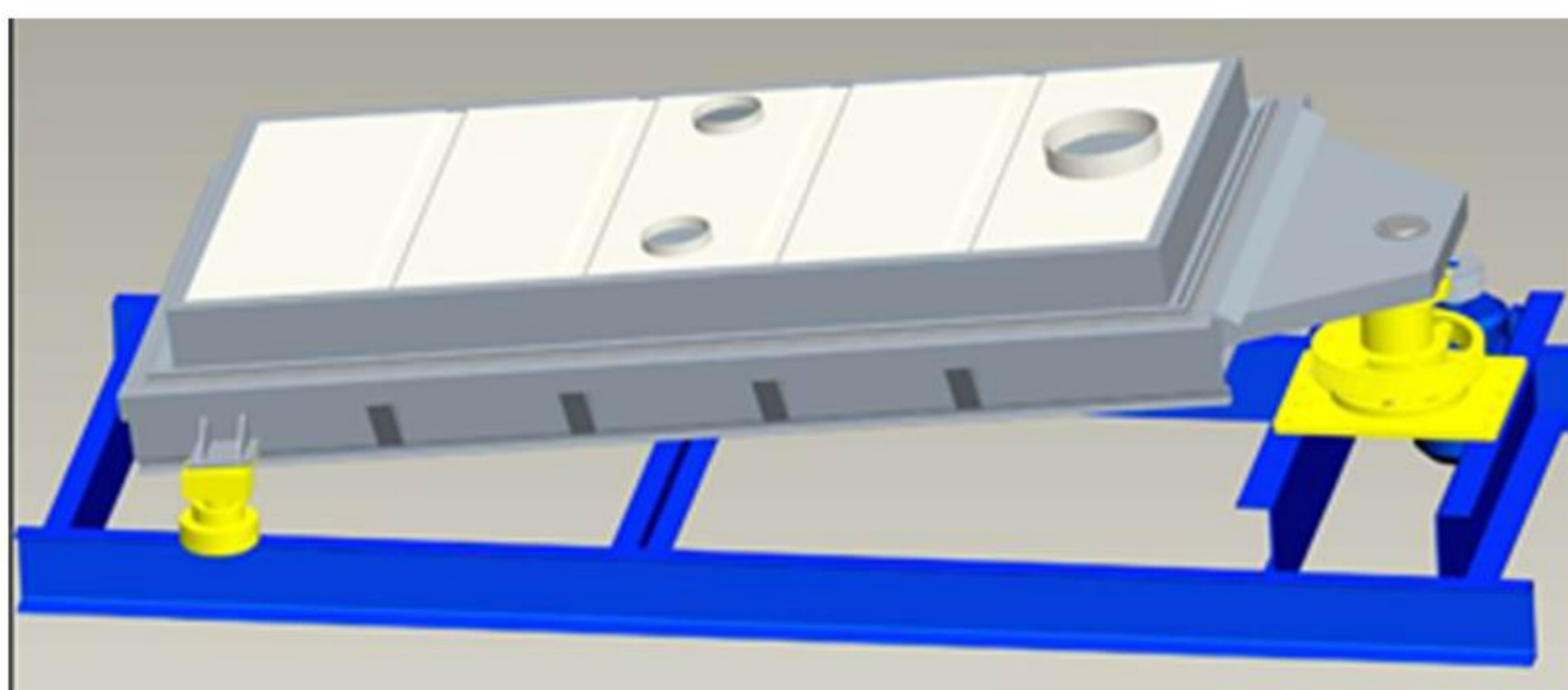

M&Y Screening Technology could select the proper M series gyratory screener base on your actual request, pedestal model and suspension model screener share the same screening principle, could choose the right installation method according to the upstream and downstream equipments and space.



Specification



MEGA YOUNG
兆扬

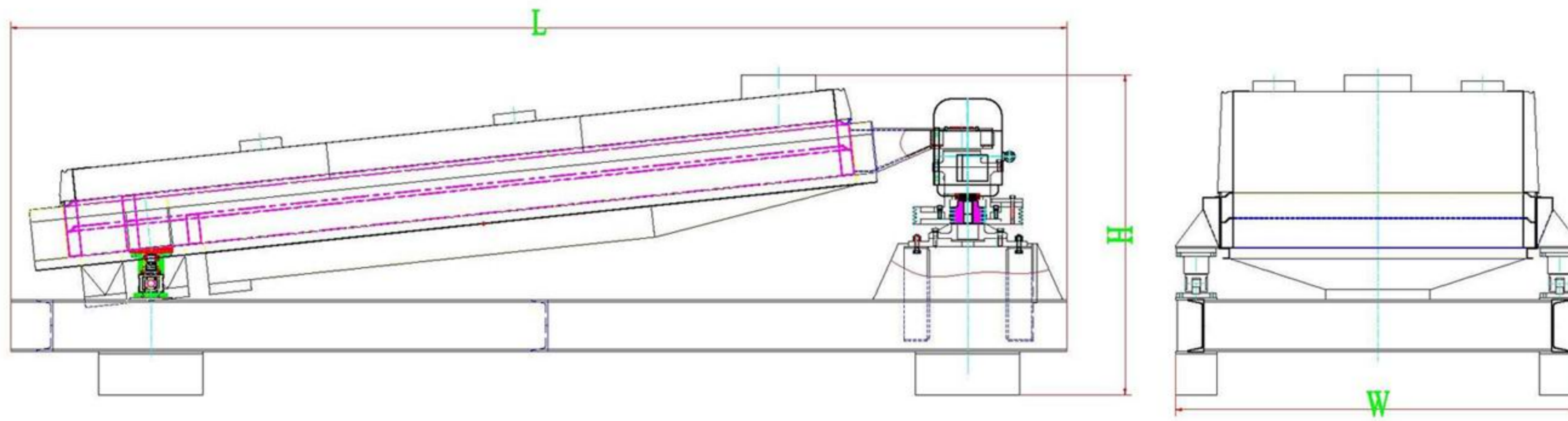

MP Screener

MP TYPE GYRATORY SCREENER									
	Model	Frequency	Amplitude	Capacity	Power	Outline (mm)			Weight
		r/min	mm	m ³ /h	kW	(L)	(W)	(H)	kg
1	MP-A14	180-220	50	4~10	2.2	3000	1390	1266	1420
	MP-B20	180-220	50	5~13	3	3700	1490	1332	1674
	MP-C24	180-220	60	8~20	3	4100	1680	1376	1842
	MP-D30	180-220	60	10~25	4	4800	1980	1442	2254
	MP-E42	180-220	88	17~40	5.5	6000	2250	1574	2981
2	MP-TC24	180-220	60	6~15	4	4100	1680	1506	2012
	MP-TD30	180-220	60	8~18	4	4800	1980	1572	2430
	MP-TE42	180-220	88	15~35	5.5	6000	2250	1704	3175
3	MP-SC24	180-220	60	5~15	4	4100	1680	1638	2132
	MP-SD30	180-220	60	8~18	5.5	4800	1980	1693	2650
	MP-SE42	180-220	88	15~33	7.5	6000	2250	1807	3438

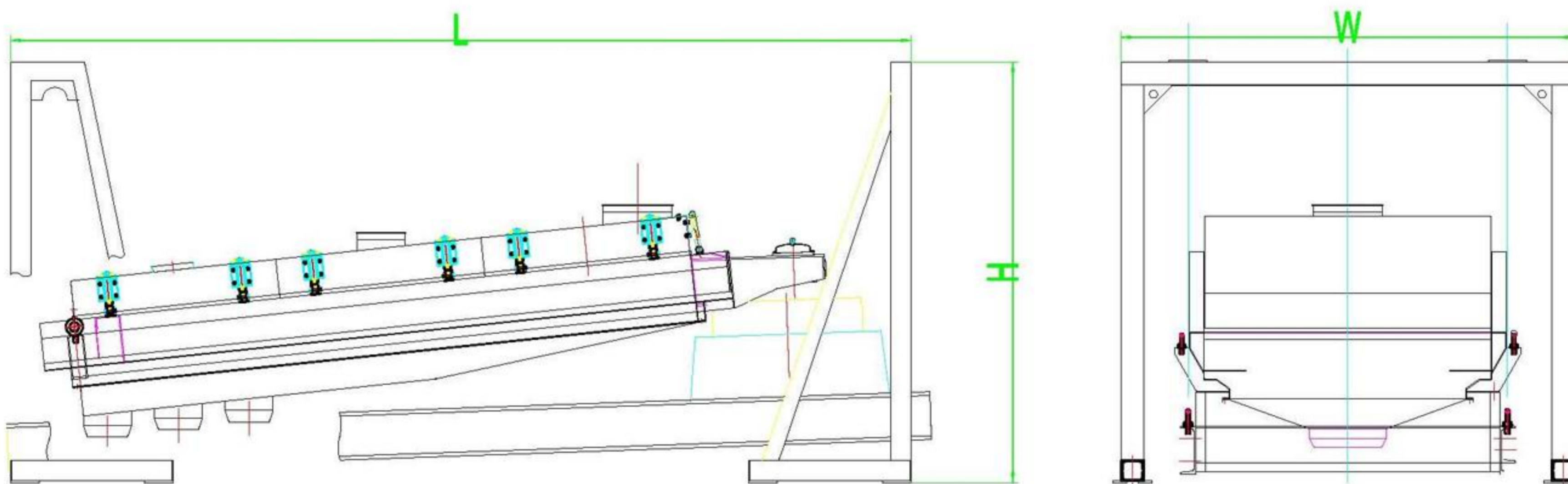

MH Screener

MH TYPE GYRATORY SCREENER									
	Model	Frequency	Amplitude	Capacity	Power	Outline (mm)			Weight
		r/min	mm	m ³ /h	kW	(L)	(W)	(H)	kg
1	MH-B20	180-220	50	5~13	3	3620	1870	2100	2463
	MH-C24	180-220	60	8~20	3	4114	2080	2100	2958
	MH-D30	180-220	60	10~25	4	4930	2370	2200	3316
	MH-E42	180-220	88	17~40	5.5	5612	2690	2200	4053
	MH-F48	180-220	88	20~45	5.5	6698	2940	2300	4335
2	MH-TB20	180-220	50	4~12	3	3620	1880	2100	2610
	MH-TC24	180-220	60	6~15	4	4114	2080	2100	3177
	MH-TD30	180-220	60	8~18	4	4930	2370	2200	3494
	MH-TE42	180-220	88	15~35	5.5	5612	2690	2200	4413
	MH-TF48	180-220	88	18~44	7.5	6498	2940	2300	4756
3	MH-SC24	180-220	60	5~15	4	4114	2080	2200	3395
	MH-SD30	180-220	60	8~18	5.5	4930	2370	2200	3872
	MH-SE42	180-220	88	15~32	7.5	5612	2690	2200	4786
	MH-SF48	180-220	88	18~42	7.5	6698	2940	2300	5337



Chemical Material



Mineral/sand



Plastic



Recycling



Wooden dust

As one of our major production, we has sold hundreds sets of Gyratory screener to different industry application customer in the past over ten years, M series gyratory screener is widely used many industry such as chemical, agriculture, food, medicine, mineral, plastic and recycling industry etc, its steady working performance and high screening efficiency has been proven .



Grain



Food

Our service

The material screening test and capacity calculation
The equipment manufacture and quality control
The shop inspection before delivery
After-sale service
The complete equipment documents and record for customer's inquiry



Material screening test, if it is first time to adopt gyratory screener for customer, or the customer is not familiar with the material characteristic, the customer could post us some material for material test screening, we could select the proper screening solution for you refer to the screening result .

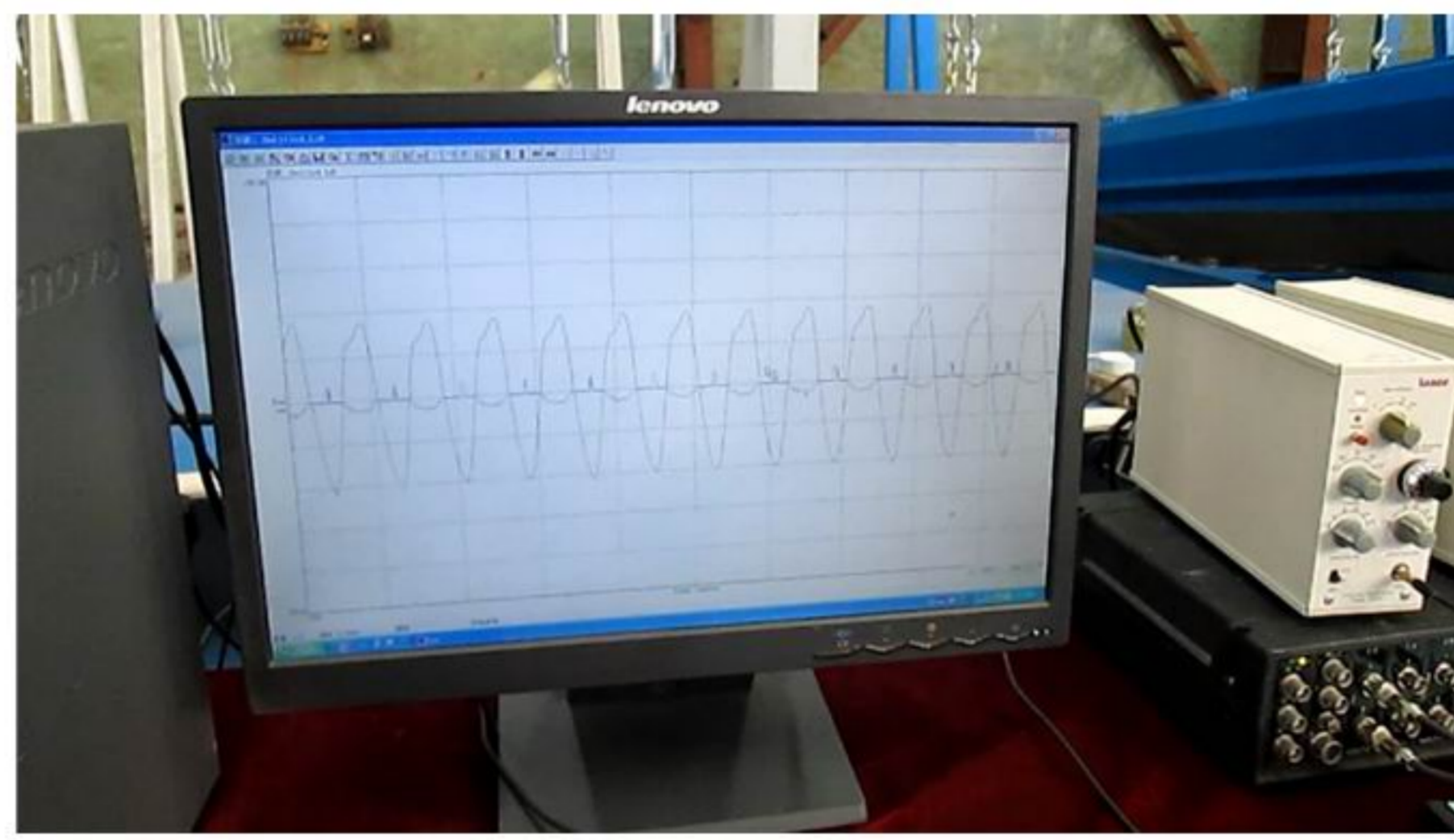

After equipment assembly work finished in workshop, our inspector will check every inspection item carefully include the noisy, temperature-up, frequency and amplitude etc so as to make sure every technical item could meet customer's request.

Some component may will be worn out after working for several weeks or months such as screen mesh, self-cleaning ball, the customer need renew the worn parts, if customers has demand on the spare parts, we will offer the specific parts as soon as possible.

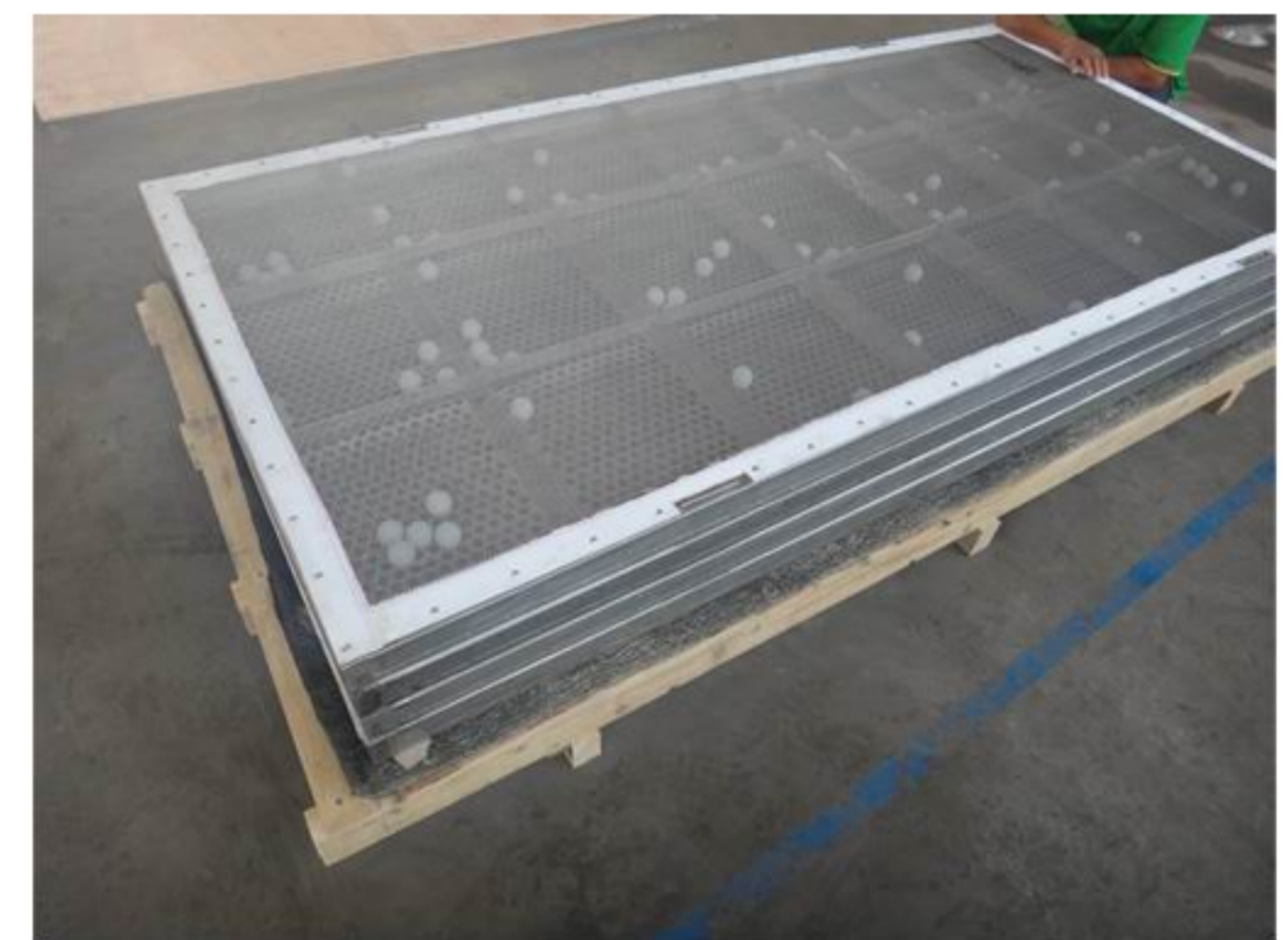
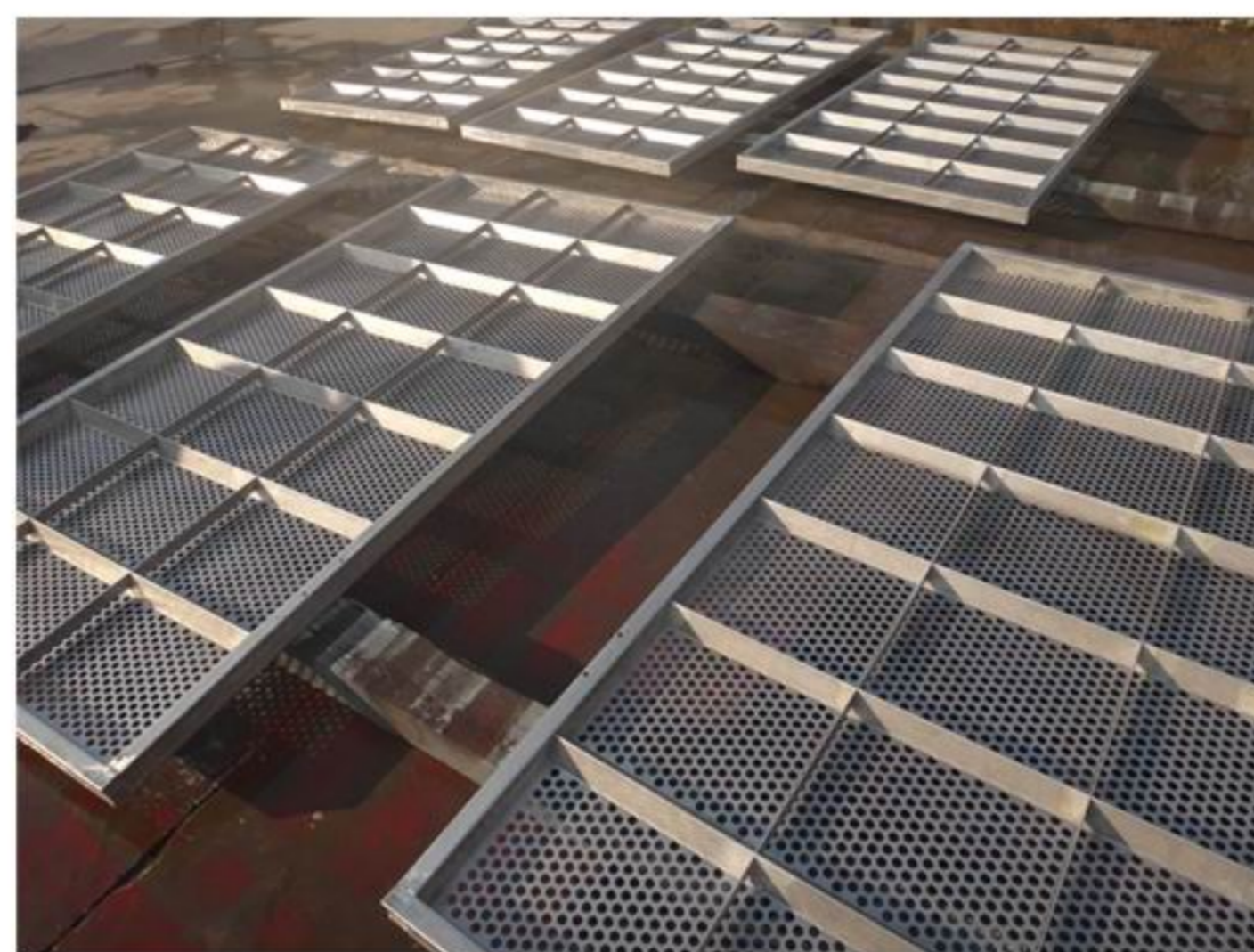

Effective service

We will prepare the complete production records for every screener, which could guarantee we could supply our customer assistance at once when customer need our after-sales service or need the production information.

Material data

We could select the screener model base on our experience and calculation, but please offer us the following data as more as possible:

1.Material Name:

2.Feeding rate: T/H

3.Material density: KG/m³

4.Mateiral moisture: %

5.Material temperature: °C

6.Surrounding temperature: °C

7.Deck Layer No.:

8.Aperture size of each deck: (Following is refer to three layers)

1st layer: mm 2^{ed} layer: mm 3rd layer: mm

9.Material size distribution (following is refer to 3 layers deck, fill it base on actual request):

Over 1st layer: % Between 1st layer and 2^{ed} layer: %

Between 2^{ed} and 3rd : % Under 3rd: %

10.Screen deck material: 9.Screener box material:

We could select the screener model for you base on above data, if you do not have above material data, we could do the material screening test if you post us the material.



Gyratory screener for exportation in factory

